





**TARA Single-hole basin mixer with pop-up waste - Brushed Champagne (22kt Gold)**

TARA

22 513 892



- 165mm projection
- 1 1/4" pop-up waste
- pivotable spout 360°
- circular, air-enriched flow
- height of mixer 295 mm
- height up to aerator 172 mm
- hole diameter 35 mm
- rosette Ø 59 mm
- 2 x pressure hose with 3/8" cap nut
- max. flow 4.5 l/min
- lead-free
- This product can help a building meet the requirements of Green Building Rating Systems, e.g. LEED®, BREEAM®, DGNB

	Brushed Champagne (22kt Gold)	22 513 892-46 0010
	Chrome	22 513 892-00 0010
	Brushed Platinum	22 513 892-06 0010
	Platinum	22 513 892-08 0010
	Dark Chrome	22 513 892-19 0010
	Brushed Durabrass (23kt Gold)	22 513 892-28 0010
	Matte Black	22 513 892-33 0010
	Champagne (22kt Gold)	22 513 892-47 0010
	Brushed Chrome	22 513 892-93 0010
	Brushed Dark Platinum	22 513 892-99 0010



TARA Single-hole basin mixer with pop-up waste - Brushed Champagne (22kt Gold)

TARA

22 513 892  
mm [inches]

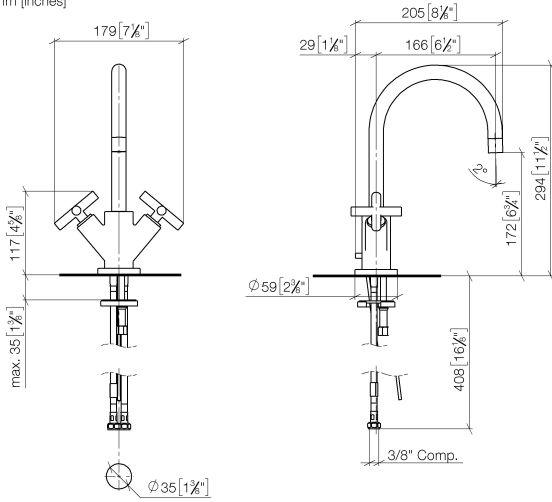

Flow rate chart



Codes & Standards

ADA

ASME  
A112.18.1/CSA  
B125.1

California Energy  
Commission  
(CEC)

NSF/ANSI 372

NSF/ANSI/CAN  
61



TARA Single-hole basin mixer with pop-up waste - Brushed Champagne (22kt Gold)

---

TARA

22 513 892

Certificates

---

IAPMO\_N-4976.

IAPMO\_6397.

**TARA Single-hole basin mixer with pop-up waste - Brushed Champagne (22kt Gold)**

TARA

22 513 892  
Parts for other  
finishes can be found  
here: [Chrome](#)

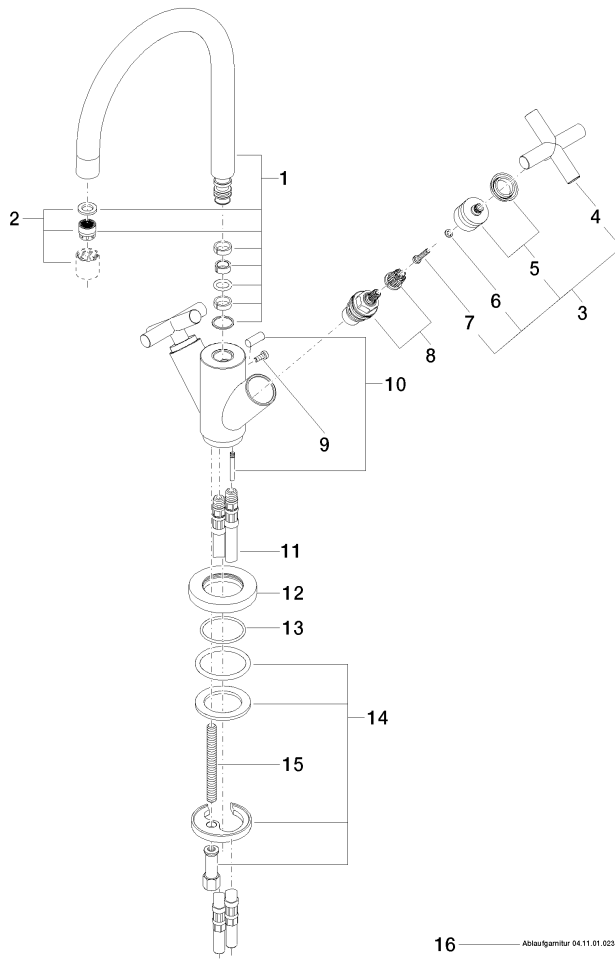

16 ——— Ablaufgarnitur 04.11.01.022.00-ff